

IVOL[®]

PORTUGAL

PONTEIRAS DE ESCAPE

EXHAUST TRIMS

EMBOUTS D'ÉCHAPPEMENT

IVOL

Industrias Metálicas Moura Vouga, Lda

Rua 25 de Abril, nº 100 r/c

Mourisca do Vouga
3750-778 Trofa - Águeda
Aveiro

Tlf. 00351 **234 639 100**

Fax. 00351 **234 639 101**

E-mail. geral@ivol.pt

www.ivol.pt



ON THE ROAD

PONTEIRAS DE ESCAPE
EXHAUST TRIMS
EMBOUTS D'ÉCHAPPEMENT

IVOL®

PONTEIRA DUPLA
DOUBLE TRIM
D'ÉCHAPPEMENT DOUBLE

403

PAR
SET
PAIRE



Saída de escape
Exhaust exit
Sortie d'échappement



Sem miolo
Without silencer
Sans Intérieur



Solda
Welding
Soudure



Diâmetro máximo entrada
Maximum Fit size
Diamètre maximum d'entrée



DIREITA
RIGHT
DROIT



ESQUERDA
LEFT
GAUCHE

Referência Reference Référence	Tipo Type Type	D. máx. entrada Max. Fit size D. max. d'entrée	Fixação Fixation Fixation	Miolo Silencer Intérieur	Material Material Matériel
403.1-60 set	Dupla Double Double	60mm	Solda Welding Soudure	Sem miolo Without silencer Sans intérieur	Inox

Esquerda
Left
Gauche

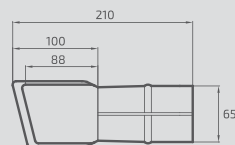
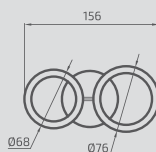

Par
Set
Paire

Direita
Right
Droit

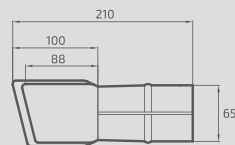
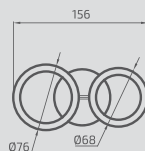

PONTEIRA DUPLA
DOUBLE TRIM
D'ÉCHAPPEMENT DOUBLE

PAR
SET
PAIRE

404



DIREITA
RIGHT
DROIT



ESQUERDA
LEFT
GAUCHE



Saída de escape
Exhaust exit
Sortie d'échappement



Sem miolo
Without silencer
Sans Intérieur



Solda
Welding
Soudure



Diâmetro máximo entrada
Maximum Fit size
Diamètre maximum d'entrée

Referência Reference Référence	Tipo Type Type	D. máx. entrada Max. Fit size D. max. d'entrée	Fixação Fixation Fixation	Miolo Silencer Intérieur	Material Material Matériel
404.1-60 set	Dupla Double Double	60mm	Solda Welding Soudure	Sem miolo Without silencer Sans intérieur	Inox

Esquerda
Left
Gauche

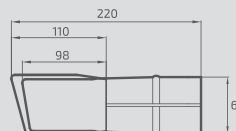
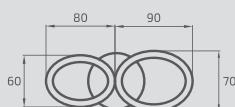

Par
Set
Paire

Direita
Right
Droit

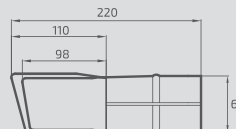
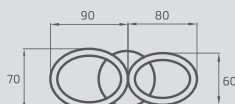

PONTEIRA REDONDA
 ROUND TRIM
 EMBOUT ROND

405



Saída de escape
 Exhaust exit
 Sortie d'échappement



Sem miolo
 Without silencer
 Sans Intérieur

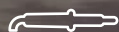

Solda
 Welding
 Soudure



Diâmetro máximo entrada
 Maximum Fit size
 Diamètre maximum d'entrée

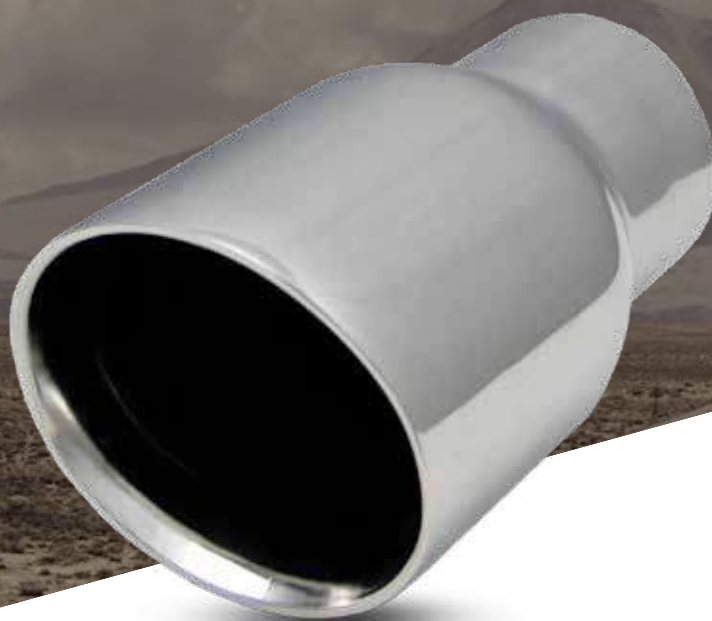

Referência Reference Référence	Tipo Type Type	D. máx. entrada Max. Fit size D. max. d'entrée	Fixação Fixation Fixation	Miolo Silencer Intérieur	Material Material Matériel
405.1-60	Redonda Round Rond	60mm	Solda Welding Soudure	Sem miolo Without silencer Sans intérieur	Inox

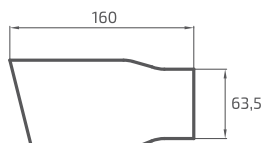
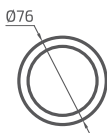

PONTEIRA REDONDA
ROUND TRIM
EMBOU T ROND

415



Saída de escape
Exhaust exit
Sortie d'échappement



Sem miolo
Without silencer
Sans Intérieur

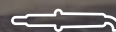

Solda
Welding
Soudure



Diâmetro máximo entrada
Maximum Fit size
Diamètre maximum d'entrée

Referência Reference Référence	Tipo Type Type	D. máx. entrada Max. Fit size D. max. d'entrée	Fixação Fixation Fixation	Miolo Silencer Intérieur	Material Material Matériel
415.1-60	Redonda Round Rond	60mm	Solda Welding Soudure	Sem miolo Without silencer Sans intérieur	Inox

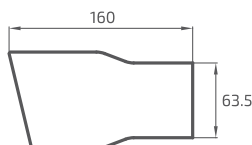
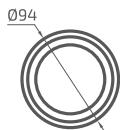

PONTEIRA DUPLA
DOUBLE TRIM
D'ÉCHAPPEMENT DOUBLE

423



Saída de escape
 Exhaust exit
 Sortie d'échappement



Com miolo
 With silencer
 Avec intérieur



Solda
 Welding
 Soudure



Diâmetro máximo entrada
 Maximum fit size
 Diamètre maximum d'entrée



Referência Reference Référence	Tipo Type Type	D. máx. entrada Max. fit size D. max. d'entrée	Fixação Fixation Fixation	Miolo Silencer Intérieur	Material Material Matériel
423B1-50	Dupla Double Double	50mm	Solda Welding Soudure	Com miolo With silencer Avec intérieur	Inox

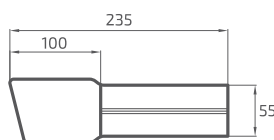
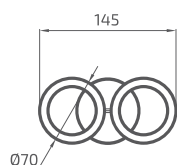

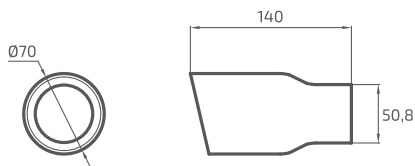

Referência Reference Référence	Tipo Type Type	D. máx. entrada Max. Fit size D. max. d'entrée	Fixação Fixation Fixation	Miolo Silencer Intérieur	Material Material Matériel
432.1-48	Redonda Round Rond	48mm	Solda Welding Soudure	Sem miolo Without silencer Sans intérieur	Inox



Saída de escape
Exhaust exit
Sortie d'échappement



Sem miolo
Without silencer
Sans Intérieur



Solda
Welding
Soudure



Diâmetro máximo entrada
Maximum Fit size
Diamètre maximum d'entrée

432

PONTEIRA REDONDA
ROUND TRIM
EMBOUT ROND

PONTEIRA DUPLA
DOUBLE TRIM
D'ÉCHAPPEMENT DOUBLE

433

PAR
SET
PAIRE



Saída de escape
Exhaust exit
Sortie d'échappement



Com miolo
With silencer
Avec intérieur



Solda
Welding
Soudure



Diâmetro máximo entrada
Maximum Fit size
Diamètre maximum d'entrée



ESQUERDA
LEFT
GAUCHE



DIREITA
RIGHT
DROIT

Referência Reference Référence	Tipo Type Type	D. máx. entrada Max. Fit size D. max. d'entrée	Fixação Fixation Fixation	Miolo Silencer Intérieur	Material Material Matériel
433B1-50 set	Dupla Double Double	50mm	Solda Welding Soudure	Com miolo With silencer Avec intérieur	Inox

Par
Set
Paire

Esquerda
Left
Gauche

Direita
Right
Droit

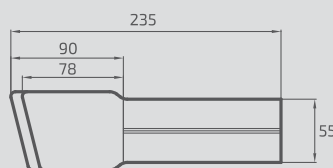
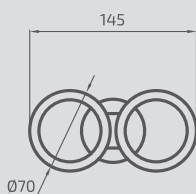

PONTEIRA REDONDA
ROUND TRIM
EMBOUT ROND

438



Saída de escape
Exhaust exit
Sortie d'échappement



Com miolo
With silencer
Avec intérieur



Solda
Welding
Soudure



Diâmetro máximo entrada
Maximum Fit size
Diamètre maximum d'entrée

Referência Reference Référence	Tipo Type Type	D. máx. entrada Max. Fit size D. max. d'entrée	Fixação Fixation Fixation	Miolo Silencer Intérieur	Material Material Matériel
438B1-60	Redonda Round Rond	60mm	Solda Welding Soudure	Com miolo With silencer Avec intérieur	Inox

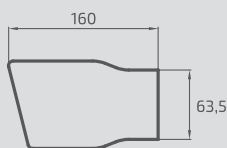
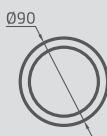

PONTEIRA RETANGULAR
RECTANGULAR TRIM
EMBOUT RECTANGULAIRE

442

PAR SET PAIRE



Saída de escape
Exhaust exit
Sortie d'échappement



Sem miolo
Without silencer
Sans Intérieur



Solda
Welding
Soudure



Diâmetro máximo entrada
Maximum Fit size
Diamètre maximum d'entrée

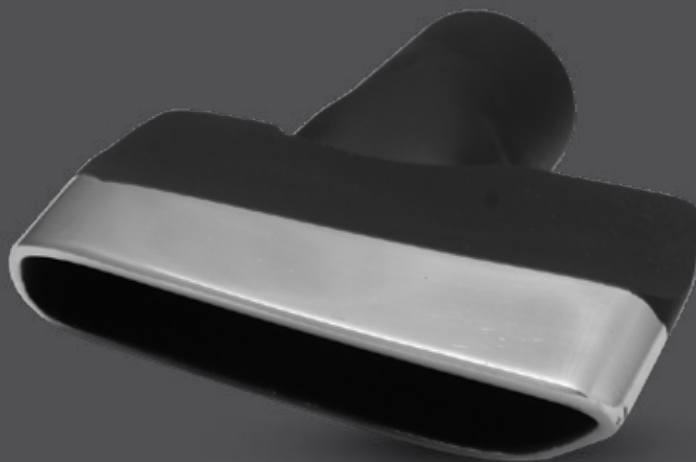

ESQUERDA
LEFT
GAUCHE

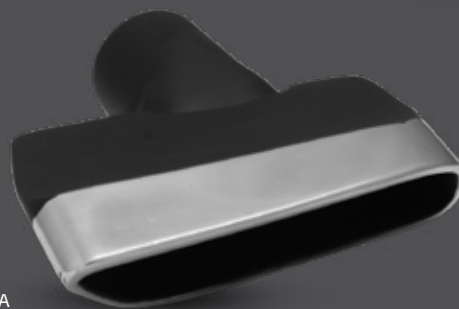

DIREITA
RIGHT
DROIT

Referência Reference Référence	Tipo Type Type	D. máx. entrada Max. Fit size D. max. d'entrée	Fixação Fixation Fixation	Miolo Silencer Intérieur	Material Material Matériel
442.1 set	Retangular Rectangular Rectangulaire	60mm	Solda Welding Soudure	Sem miolo Without silencer Sans intérieur	Alumínio/Inox Aluminum/Inox Aluminium/Inox

Par
Set
Paire

Direita
Right
Droit

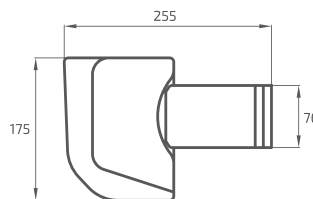
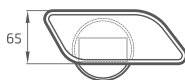

Esquerda
Left
Gauche

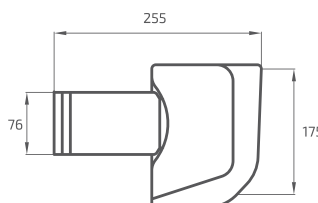
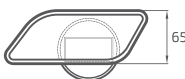

PONTEIRA REDONDA
ROUND TRIM
EMBOUT ROND

500



Saída de escape
Exhaust exit
Sortie d'échappement



Sem miolo
Without silencer
Sans Intérieur



Parafuso
Screw
Vis



Min.



Máx.

Diâmetro entrada
Fit size
Diamètre d'entrée

Referência Reference Référence	Tipo Type	D. entrada Fit size D. d'entrée	Fixação Fixation Fixation	Miolo Silencer Intérieur	Material Material Matériel
500.2-60	Redonda Round Rond	60mm	Parafuso Screw Vis	Sem miolo Without silencer Sans intérieur	Inox

Ø63,5



150

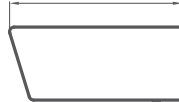

PONTEIRA REDONDA
ROUND TRIM
EMBOUT ROND

501



Saída de escape
Exhaust exit
Sortie d'échappement



Sem miolo
Without silencer
Sans Intérieur



Com miolo
With silencer
Avec intérieur



Solda
Welding
Soudure



Diâmetro máximo entrada
Maximum Fit size
Diamètre maximum d'entrée



Referência Reference Référence	Tipo Type Type	D. máx. entrada Max. Fit size D. max. d'entrée	Fixação Fixation Fixation	Miolo Silencer Intérieur	Material Material Matériel
501.1-48	Redonda Round Rond	48mm	Solda Welding Soudure	Sem miolo Without silencer Sans intérieur	Inox
501.B1-48	Redonda Round Rond	48mm	Solda Welding Soudure	Com miolo With silencer Avec intérieur	Inox

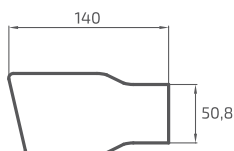
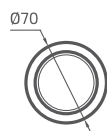

PONTEIRA DUPLA
DOUBLE TRIM
D'ÉCHAPPEMENT DOUBLE

502



Saída de escape
Exhaust exit
Sortie d'échappement



Sem miolo
Without silencer
Sans intérieur



Com miolo
With silencer
Avec intérieur



Solda
Welding
Soudure



Diâmetro máximo entrada
Maximum Fit size
Diamètre maximum d'entrée



Referência Reference Référence	Tipo Type Type	D. máx. entrada Max. Fit size D. max. d'entrée	Fixação Fixation Fixation	Miolo Silencer Intérieur	Material Material Matériel
502.1-50	Dupla Double Double	50mm	Solda Welding Soudure	Sem miolo Without silencer Sans intérieur	Inox
502B1-50	Dupla Double Double	50mm	Solda Welding Soudure	Com miolo With silencer Avec intérieur	Inox

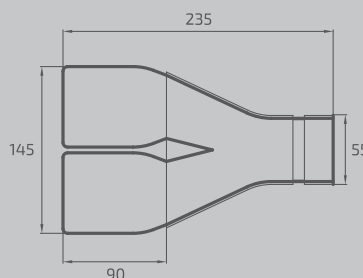
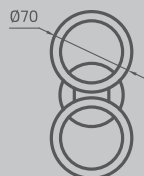

PONTEIRA REDONDA
ROUND TRIM
EMBOUT ROND

503



Saída de escape
Exhaust exit
Sortie d'échappement



Sem miolo
Without silencer
Sans Intérieur



Com miolo
With silencer
Avec intérieur



Solda
Welding
Soudure



Diâmetro máximo entrada
Maximum Fit size
Diamètre maximum d'entrée



Referência Reference Référence	Tipo Type Type	D. máx. entrada Max. Fit size D. max. d'entrée	Fixação Fixation Fixation	Miolo Silencer Intérieur	Material Material Matériel
503.1-48	Redonda Round Rond	48mm	Solda Welding Soudure	Sem miolo Without silencer Sans intérieur	Inox
503B1-48	Redonda Round Rond	48mm	Solda Welding Soudure	Com miolo With silencer Avec intérieur	Inox

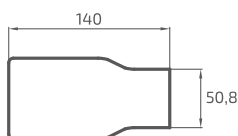
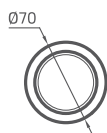

PONTEIRA REDONDA
ROUND TRIM
EMBOU ROND

504



Saída de escape
Exhaust exit
Sortie d'échappement



Com miolo
With silencer
Avec intérieur



Solda
Welding
Soudure



Diâmetro máximo entrada
Maximum Fit size
Diamètre maximum d'entrée



Referência Reference Référence	Tipo Type Type	D. máx. entrada Max. Fit size D. max. d'entrée	Fixação Fixation Fixation	Miolo Silencer Intérieur	Material Material Matériel
504B1-60	Redonda Round Rond	60mm	Solda Welding Soudure	Com miolo With silencer Avec intérieur	Inox

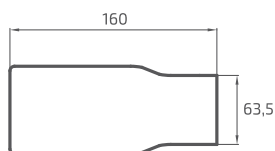
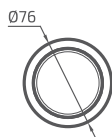

PONTEIRA REDONDA
 ROUND TRIM
 EMBOUT ROND

505



Saída de escape
 Exhaust exit
 Sortie d'échappement



Com miolo
 With silencer
 Avec intérieur



Solda
 Welding
 Soudure



Diâmetro máximo entrada
 Maximum Fit size
 Diamètre maximum d'entrée



Referência Reference Référence	Tipo Type Type	D. máx. entrada Max. Fit size D. max. d'entrée	Fixação Fixation Fixation	Miolo Silencer Intérieur	Material Material Matériel
505B1-60	Redonda Round Rond	60mm	Solda Welding Soudure	Com miolo With silencer Avec intérieur	Inox

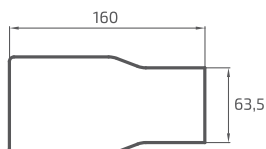
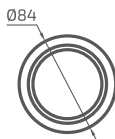

PONTEIRA REDONDA
ROUND TRIM
EMBOU T ROND

506



Saída de escape
Exhaust exit
Sortie d'échappement



Miolo perfurado
Perforated silencer
Intérieur perforé



Com miolo
With silencer
Avec intérieur



Solda
Welding
Soudure



Diâmetro máximo entrada
Maximum Fit size
Diamètre maximum d'entrée



Referência Reference Référence	Tipo Type Type	D. máx. entrada Max. Fit size D. max. d'entrée	Fixação Fixation Fixation	Miolo Silencer Intérieur	Material Material Matériel
506A1-60	Redonda Round Rond	60mm	Solda Welding Soudure	Perfurado Perforated Perforé	Inox
506B1-60	Redonda Round Rond	60mm	Solda Welding Soudure	Com miolo With silencer Avec intérieur	Inox

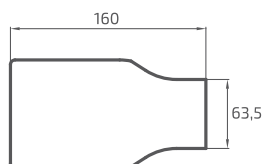
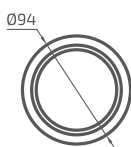

PONTEIRA OVAL
OVAL TRIM
EMBOUT OVALE

507



Saída de escape
Exhaust exit
Sortie d'échappement



Sem miolo
Without silencer
Sans Intérieur



Com miolo
With silencer
Avec intérieur



Solda
Welding
Soudure



Diâmetro máximo entrada
Maximum Fit size
Diamètre maximum d'entrée



Referência Reference Référence	Tipo Type Type	D. máx. entrada Max. Fit size D. max. d'entrée	Fixação Fixation Fixation	Miolo Silencer Intérieur	Material Material Matériel
507.1-60	Redonda Round Rond	60mm	Solda Welding Soudure	Sem miolo Without silencer Sans intérieur	Inox
507B1-60	Redonda Round Rond	60mm	Solda Welding Soudure	Com miolo With silencer Avec intérieur	Inox

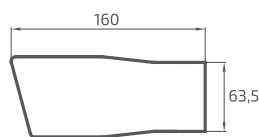
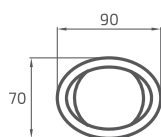

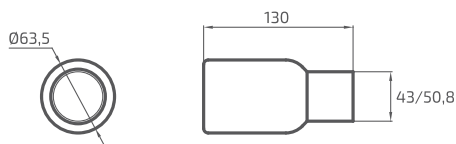

Referência Reference Référence	Tipo Type Type	D. máx. entrada Max. Fit size D. max. d'entrée	Fixação Fixation Fixation	Miolo Silencer Intérieur	Material Material Matériel
510B1-40	Redonda Round Rond	40mm	Solda Welding Soudure	Com miolo With silencer Avec intérieur	Inox
510B1-48	Redonda Round Rond	48mm	Solda Welding Soudure	Com miolo With silencer Avec intérieur	Inox



Saída de escape
Exhaust exit
Sortie d'échappement



Com miolo
With silencer
Avec intérieur



Solda
Welding
Soudure



Diâmetro máximo entrada
Maximum Fit size
Diamètre maximum d'entrée

510

PONTEIRA REDONDA
ROUND TRIM
EMBOUT ROND

PONTEIRA OVAL
OVAL TRIM
EMBOUT OVALE

512

PAR
SET
PAIRE



Saída de escape
Exhaust exit
Sortie d'échappement



Com miolo
With silencer
Avec intérieur



Solda
Welding
Soudure



Diâmetro máximo entrada
Maximum Fit size
Diamètre maximum d'entrée



ESQUERDA
LEFT
GAUCHE



DIREITA
RIGHT
DROIT

Referência Reference Référence	Tipo Type Type	D. máx. entrada Max. Fit size D. max. d'entrée	Fixação Fixation Fixation	Miolo Silencer Intérieur	Material Material Matériel
512B1-60 set	Oval Oval Ovale	60mm	Solda Welding Soudure	Com miolo With silencer Avec intérieur	Inox

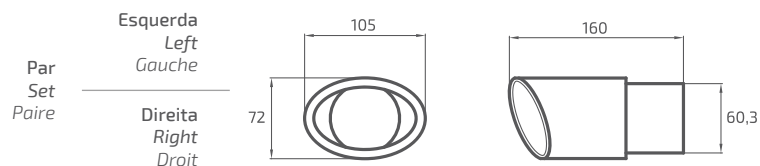

PONTEIRA OVAL
OVAL TRIM
EMBOUT OVALE

513



Saída de escape
Exhaust exit
Sortie d'échappement



Sem miolo
Without silencer
Sans Intérieur



Com miolo
With silencer
Avec intérieur



Solda
Welding
Soudure



Diâmetro máximo entrada
Maximum Fit size
Diamètre maximum d'entrée



Referência Reference Référence	Tipo Type Type	D. máx. entrada Max. Fit size D. max. d'entrée	Fixação Fixation Fixation	Miolo Silencer Intérieur	Material Material Matériel
513.1-48	Oval Oval Ovale	48mm	Solda Welding Soudure	Sem miolo Without silencer Sans intérieur	Inox
513B1-48	Oval Oval Ovale	48mm	Solda Welding Soudure	Com miolo With silencer Avec intérieur	Inox

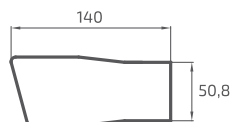
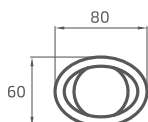

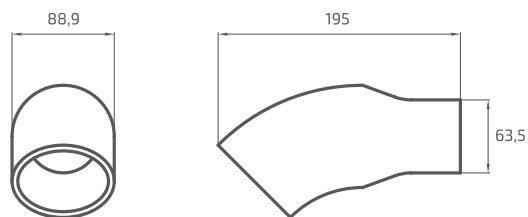

Referência Reference Référence	Tipo Type Type	D. máx. entrada Max. Fit size D. max. d'entrée	Fixação Fixation Fixation	Miolo Silencer Intérieur	Material Material Matériel
516.1-60	Diesel	60mm	Solda Welding Soudure	Sem miolo Without silencer Sans intérieur	Inox



Saída de escape
Exhaust exit
Sortie d'échappement



Sem miolo
Without silencer
Sans intérieur



Solda
Welding
Soudure



Diâmetro máximo entrada
Maximum Fit size
Diamètre maximum d'entrée



516

PONTEIRA DIESEL
DIESEL TRIM
EMBOUT D'ÉCHAPPEMENT DIESEL

PONTEIRA RETANGULAR
RECTANGULAR TRIM
EMBOUT RECTANGULAIRE

519



Saída de escape
Exhaust exit
Sortie d'échappement



Miolo perfurado
Perforated silencer
Intérieur perforé



Solda
Welding
Soudure



Diâmetro máximo entrada
Maximum fit size
Diamètre maximum d'entrée



Referência Reference Référence	Tipo Type Type	D. máx. entrada Max. Fit size D. max. d'entrée	Fixação Fixation Fixation	Miolo Silencer Intérieur	Material Material Matériel
519A1-60	Retangular Rectangular Rectangulaire	60mm	Solda Welding Soudure	Perfurado Perforated Perforé	Inox

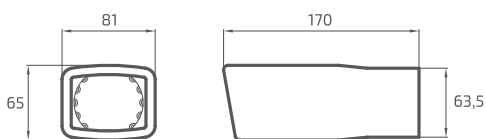

PONTEIRA RETANGULAR
RECTANGULAR TRIM
EMBOUIT RECTANGULAIRE

520



Saída de escape
Exhaust exit
Sortie d'échappement



Miolo perfurado
Perforated silencer
Intérieur perforé



Solda
Welding
Soudure



Diâmetro máximo entrada
Maximum fit size
Diamètre maximum d'entrée



Referência Reference Référence	Tipo Type Type	D. máx. entrada Max. fit size D. max. d'entrée	Fixação Fixation Fixation	Miolo Silencer Intérieur	Material Material Matériel
520A1-60	Retangular Rectangular Rectangulaire	60mm	Solda Welding Soudure	Perfurado Perforated Perforé	Inox

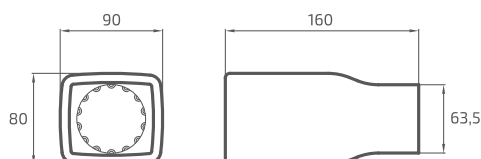

PONTEIRA RETANGULAR
RECTANGULAR TRIM
EMBOUT RECTANGULAIRE

521



Saída de escape
Exhaust exit
Sortie d'échappement



Miolo perfurado
Perforated silencer
Intérieur perforé



Solda
Welding
Soudure



Diâmetro máximo entrada
Maximum fit size
Diamètre maximum d'entrée



Referência Reference Référence	Tipo Type Type	D. máx. entrada Max. Fit size D. max. d'entrée	Fixação Fixation Fixation	Miolo Silencer Intérieur	Material Material Matériel
521A1-60	Retangular Rectangular Rectangulaire	60mm	Solda Welding Soudure	Perfurado Perforated Perforé	Inox

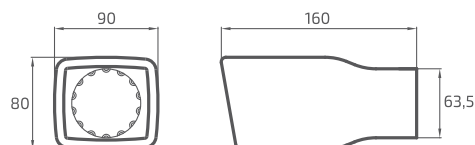

PONTEIRA RETANGULAR
RECTANGULAR TRIM
EMBOUT RECTANGULAIRE

522



Saída de escape
Exhaust exit
Sortie d'échappement



Com miolo
With silencer
Avec intérieur



Solda
Welding
Soudure



Diâmetro máximo entrada
Maximum Fit size
Diamètre maximum d'entrée



Referência Reference Référence	Tipo Type Type	D. máx. entrada Max. Fit size D. max. d'entrée	Fixação Fixation Fixation	Miolo Silencer Intérieur	Material Material Matériel
522B1-57	Retangular Rectangular Rectangulaire	57mm	Solda Welding Soudure	Com miolo With silencer Avec intérieur	Inox

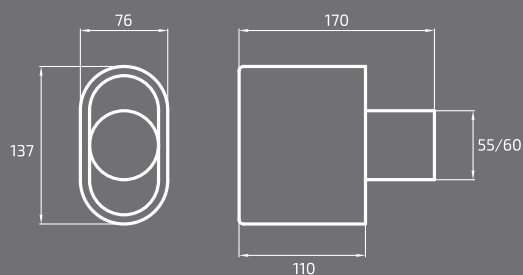



*UMA MARCA,
UM PRODUTO
PORTUGUÊS!*

PONTEIRA REDONDA
ROUND TRIM
EMBOUT ROND

524



Saída de escape
 Exhaust exit
 Sortie d'échappement



Com miolo
 With silencer
 Avec intérieur



Solda
 Welding
 Soudure



Diâmetro máximo entrada
 Maximum Fit size
 Diamètre maximum d'entrée



Referência Reference Référence	Tipo Type Type	D. máx. entrada Max. Fit size D. max. d'entrée	Fixação Fixation Fixation	Miolo Silencer Intérieur	Material Material Matériel
524B1-73	Redonda Round Rond	73mm	Solda Welding Soudure	Com miolo With silencer Avec intérieur	Inox

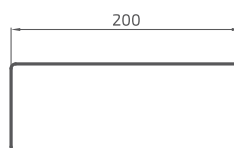
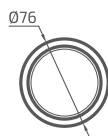

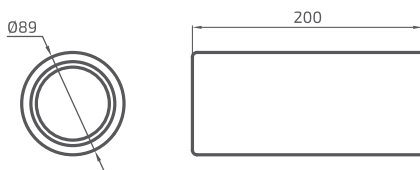

Referência Reference Référence	Tipo Type Type	D. máx. entrada Max. Fit size D. max. d'entrée	Fixação Fixation Fixation	Miolo Silencer Intérieur	Material Material Matériel
526B1-85	Redonda Round Rond	85mm	Solda Welding Soudure	Com miolo With silencer Avec intérieur	Inox



Saída de escape
Exhaust exit
Sortie d'échappement



Com miolo
With silencer
Avec intérieur

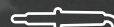

Solda
Welding
Soudure



Diâmetro máximo entrada
Maximum Fit size
Diamètre maximum d'entrée

526

PONTEIRA REDONDA
ROUND TRIM
EMBOUT ROND

PONTEIRA OVAL
OVAL TRIM
EMBOUIT OVALE

528



Saída de escape
Exhaust exit
Sortie d'échappement



Com miolo
With silencer
Avec intérieur



Solda
Welding
Soudure



Diâmetro máximo entrada
Maximum Fit size
Diamètre maximum d'entrée



Referência Reference Référence	Tipo Type Type	D. máx. entrada Max. Fit size D. max. d'entrée	Fixação Fixation Fixation	Miolo Silencer Intérieur	Material Material Matériel
528B1-52	Oval Oval Ovale	52mm	Solda Welding Soudure	Com miolo With silencer Avec intérieur	Inox

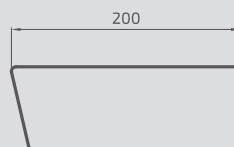
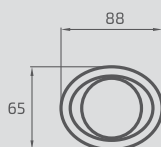

PONTEIRA RETANGULAR
RECTANGULAR TRIM
EMBOUT RECTANGULAIRE

530



Saída de escape
Exhaust exit
Sortie d'échappement



Com miolo
With silencer
Avec intérieur



Solda
Welding
Soudure



Diâmetro máximo entrada
Maximum Fit size
Diamètre maximum d'entrée

Referência Reference Référence	Tipo Type Type	D. máx. entrada Max. Fit size D. max. d'entrée	Fixação Fixation Fixation	Miolo Silencer Intérieur	Material Material Matériel
530B1-52	Retangular Rectangular Rectangulaire	52mm	Solda Welding Soudure	Com miolo With silencer Avec intérieur	Inox



PONTEIRA OVAL
OVAL TRIM
EMBOU OVALE

531



Saída de escape
Exhaust exit
Sortie d'échappement



Sem miolo
Without silencer
Sans Intérieur



Com miolo
With silencer
Avec intérieur



Solda
Welding
Soudure



Diâmetro máximo entrada
Maximum Fit size
Diamètre maximum d'entrée



Referência Reference Référence	Tipo Type Type	D. máx. entrada Max. Fit size D. max. d'entrée	Fixação Fixation Fixation	Miolo Silencer Intérieur	Material Material Matériel
531.1	Retangular Rectangular Rectangulaire	70mm	Solda Welding Soudure	Sem miolo Without silencer Sans intérieur	Inox
531B1-57	Retangular Rectangular Rectangulaire	57mm	Solda Welding Soudure	Com miolo With silencer Avec intérieur	Inox

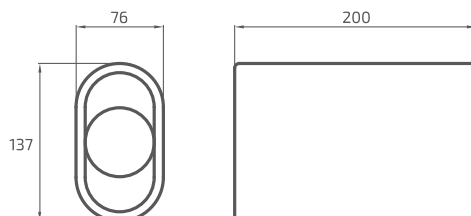

PONTEIRA RETANGULAR
RECTANGULAR TRIM
EMBOUT RECTANGULAIRE

532



Saída de escape
Exhaust exit
Sortie d'échappement



Sem miolo
Without silencer
Sans Intérieur



Com miolo
With silencer
Avec intérieur



Solda
Welding
Soudure



Diâmetro máximo entrada
Maximum Fit size
Diamètre maximum d'entrée

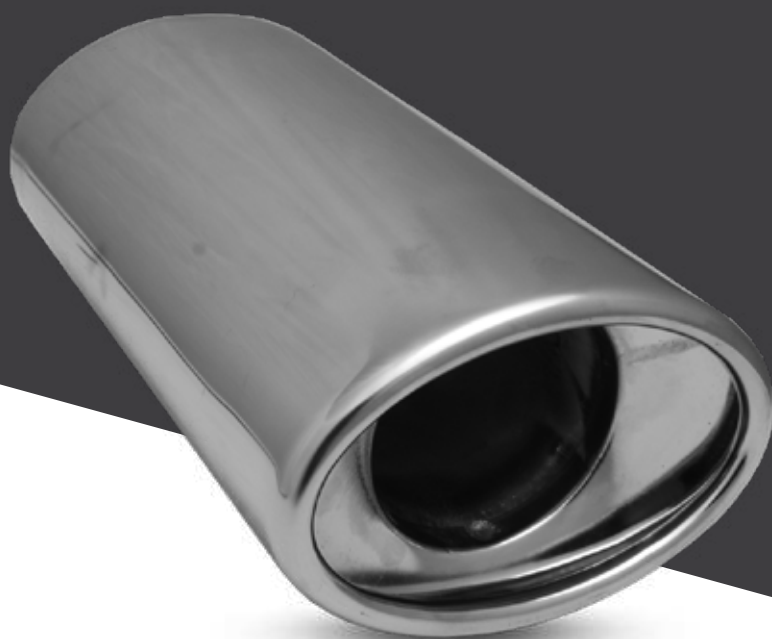

Referência Reference Référence	Tipo Type Type	D. máx. entrada Max. Fit size D. max. d'entrée	Fixação Fixation Fixation	Miolo Silencer Intérieur	Material Material Matériel
532.1	Oval Oval Ovale	75mm	Solda Welding Soudure	Sem miolo Without silencer Sans intérieur	Inox
532B1-57	Oval Oval Ovale	57mm	Solda Welding Soudure	Com miolo With silencer Avec intérieur	Inox

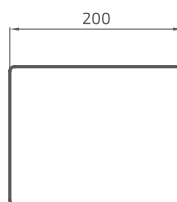
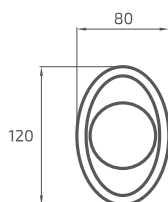

IVOL®

PONTEIRA OVAL
OVAL TRIM
EMBOUT OVALE

533



Saída de escape
Exhaust exit
Sortie d'échappement



Sem miolo
Without silencer
Sans Intérieur



Solda
Welding
Soudure



Diâmetro máximo entrada
Maximum fit size
Diamètre maximum d'entrée



Referência Reference Référence	Tipo Type Type	D. máx. entrada Max. fit size D. max. d'entrée	Fixação Fixation Fixation	Miolo Silencer Intérieur	Material Material Matériel
533.1	Oval Oval Ovale	75mm	Solda Welding Soudure	Sem miolo Without silencer Sans intérieur	Inox

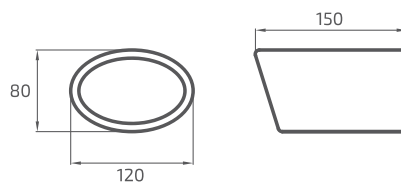

PONTEIRA OVAL
OVAL TRIM
EMBOUOT OVALE

534



Saída de escape
Exhaust exit
Sortie d'échappement



Sem miolo
Without silencer
Sans Intérieur



Solda
Welding
Soudure



Diâmetro máximo entrada
Maximum Fit size
Diamètre maximum d'entrée

Referência Reference Référence	Tipo Type Type	D. máx. entrada Max. Fit size D. max. d'entrée	Fixação Fixation Fixation	Miolo Silencer Intérieur	Material Material Matériel
534.1-60	Oval Oval Ovale	60mm	Solda Welding Soudure	Sem miolo Without silencer Sans intérieur	Inox

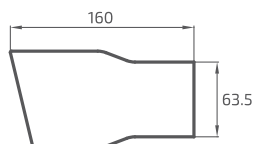
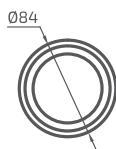

PONTEIRA OVAL
OVAL TRIM
EMBOUT OVALE

535



Saída de escape
Exhaust exit
Sortie d'échappement



Com miolo
With silencer
Avec intérieur



Solda
Welding
Soudure



Diâmetro máximo entrada
Maximum Fit size
Diamètre maximum d'entrée



Referência Reference Référence	Tipo Type Type	D. máx. entrada Max. Fit size D. max. d'entrée	Fixação Fixation Fixation	Miolo Silencer Intérieur	Material Material Matériel
535B1-57	Oval Oval Ovale	57mm	Solda Welding Soudure	Com miolo With silencer Avec intérieur	Inox

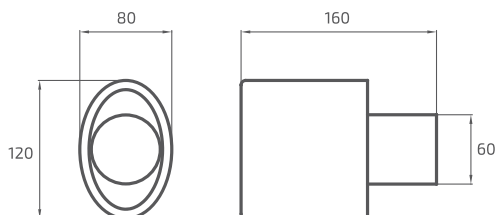

PONTEIRA DTM
DTM TRIM
EMBOU DTM

537



Saída de escape
Exhaust exit
Sortie d'échappement



Sem miolo
Without silencer
Sans Intérieur



Solda
Welding
Soudure



Diâmetro máximo entrada
Maximum Fit size
Diamètre maximum d'entrée

Referência Reference Référence	Tipo Type Type	D. máx. entrada Max. Fit size D. max. d'entrée	Fixação Fixation Fixation	Miolo Silencer Intérieur	Material Material Matériel
537.1	DTM	73mm	Solda Welding Soudure	Sem miolo Without silencer Sans intérieur	Inox

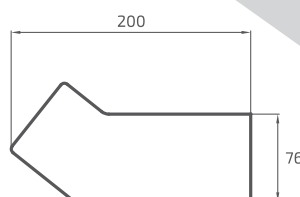
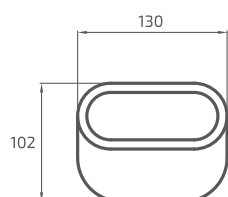

PONTEIRA REDONDA
ROUND TRIM
EMBOUIT ROND

540

541
542
543
544



Saída de escape
Exhaust exit
Sortie d'échappement



Sem miolo
Without silencer
Sans intérieur

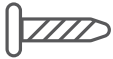

Parafuso
Screw
Vis



Min.



Máx.

Diâmetro entrada
Fit size
Diamètre d'entrée



Referência Reference Référence	Tipo Type Type	D. entrada Fit size D. d'entrée	Fixação Fixation Fixation	Miolo Silencer Intérieur	Material Material Matériel
540.2-37	Redonda Round Rond	35 37	Parafuso Screw Vis	Sem miolo Without silencer Sans intérieur	Inox
541.2-40	Redonda Round Rond	38 40	Parafuso Screw Vis	Sem miolo Without silencer Sans intérieur	Inox
542.2-42	Redonda Round Rond	41 42	Parafuso Screw Vis	Sem miolo Without silencer Sans intérieur	Inox
543.2-45	Redonda Round Rond	43 45	Parafuso Screw Vis	Sem miolo Without silencer Sans intérieur	Inox
544.2-50	Redonda Round Rond	46 50	Parafuso Screw Vis	Sem miolo Without silencer Sans intérieur	Inox

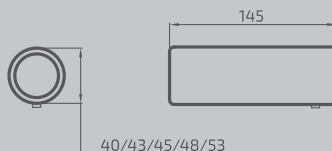

PONTEIRA OVAL
OVAL TRIM
EMBOUT OVALE

547



Saída de escape
Exhaust exit
Sortie d'échappement



Sem miolo
Without silencer
Sans Intérieur



Solda
Welding
Soudure



Diâmetro máximo entrada
Maximum Fit size
Diamètre maximum d'entrée

Referência Reference Référence	Tipo Type Type	D. máx. entrada Max. Fit size D. max. d'entrée	Fixação Fixation Fixation	Miolo Silencer Intérieur	Material Material Matériel
547.1-57	Oval Oval Ovale	57mm	Solda Welding Soudure	Sem miolo Without silencer Sans intérieur	Inox

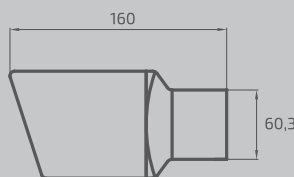
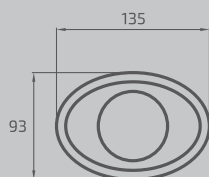

PONTEIRA REDONDA
ROUND TRIM
EMBOUT ROND

550

552
553



Saída de escape
 Exhaust exit
 Sortie d'échappement



Sem miolo
 Without silencer
 Sans intérieur



Parafuso
 Screw
 Vis



Min.



Máx.

Diâmetro entrada
 Fit size
 Diamètre d'entrée

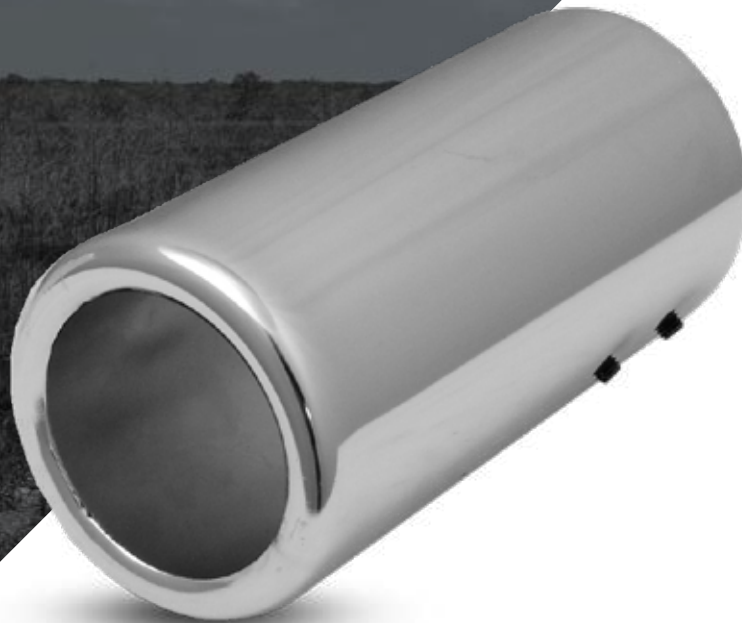

Referência Reference Référence	Tipo Type Type	D. entrada Fit size D. d'entrée	Fixação Fixation Fixation	Miolo Silencer Intérieur	Material Material Matériel
550.2-40	Redonda Round Rond	34 40	Parafuso Screw Vis	Sem miolo Without silencer Sans intérieur	Inox
552.2-53	Redonda Round Rond	47 53	Parafuso Screw Vis	Sem miolo Without silencer Sans intérieur	Inox
553.2-66	Redonda Round Rond	60 66	Parafuso Screw Vis	Sem miolo Without silencer Sans intérieur	Inox



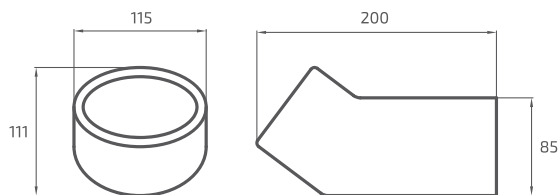

Referência Reference Référence	Tipo Type Type	D. máx. entrada Max. Fit size D. max. d'entrée	Fixação Fixation Fixation	Miolo Silencer Intérieur	Material Material Matériel
554.1	DTM	80mm	Solda Welding Soudure	Sem miolo Without silencer Sans intérieur	Inox



Saída de escape
Exhaust exit
Sortie d'échappement



Sem miolo
Without silencer
Sans Intérieur

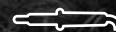

Solda
Welding
Soudure



Diâmetro máximo entrada
Maximum Fit size
Diamètre maximum d'entrée

554

PONTEIRA DTM
DTM TRIM
EMBOUIT DTM

PONTEIRA OVAL
OVAL TRIM
EMBOUIT OVALE

558

PAR
SET
PAIRE



Saída de escape
Exhaust exit
Sortie d'échappement



Sem miolo
Without silencer
Sans intérieur



Solda
Welding
Soudure



Diâmetro máximo entrada
Maximum fit size
Diamètre maximum d'entrée



DIREITA
RIGHT
DROIT



ESQUERDA
LEFT
GAUCHE

Referência Reference Référence	Tipo Type Type	D. máx. entrada Max. fit size D. max. d'entrée	Fixação Fixation Fixation	Miolo Silencer Intérieur	Material Material Matériel
558.1-57 set	Oval Oval Ovale	88mm	Solda Welding Soudure	Sem miolo Without silencer Sans intérieur	Inox

Par
Set
Paire

Esquerda
Left
Gauche

Direita
Right
Droit



PONTEIRA RETANGULAR
RECTANGULAR TRIM
EMBOUT RECTANGULAIRE

560



Saída de escape
Exhaust exit
Sortie d'échappement



Com miolo
With silencer
Avec Intérieur



Parafuso
Screw
Vis



Min.

Máx.

Diâmetro entrada
Fit size
Diamètre d'entrée



Referência Reference Référence	Tipo Type Type	D. entrada Fit size D. d'entrée	Fixação Fixation Fixation	Miolo Silencer Intérieur	Material Material Matériel
560B2-58	Retangular Rectangular Rectangulaire	58mm	Parafuso Screw Vis	Com miolo With silencer Avec intérieur	Inox

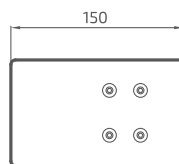
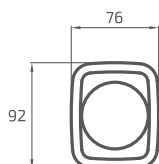

PONTEIRA RETANGULAR
RECTANGULAR TRIM
EMBOUT RECTANGULAIRE

561



Saída de escape
Exhaust exit
Sortie d'échappement



Com miolo
With silencer
Avec intérieur



Parafuso
Screw
Vis



Min.



Máx.

Diâmetro entrada
Fit size
Diamètre d'entrée



Referência Reference Référence	Tipo Type Type	D. entrada Fit size D. d'entrée	Fixação Fixation Fixation	Miolo Silencer Intérieur	Material Material Matériel
561B2-48	Retangular Rectangular Rectangulaire	48mm	Parafuso Screw Vis	Com miolo With silencer Avec intérieur	Inox

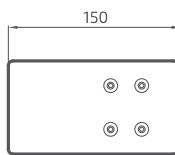
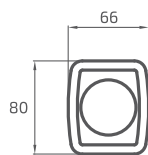

PONTEIRA REDONDA
ROUND TRIM
EMBOUOT ROND

562



Saída de escape
Exhaust exit
Sortie d'échappement



Com miolo
With silencer
Avec Intérieur



Parafuso
Screw
Vis



Diâmetro máximo entrada
Maximum Fit size
Diamètre maximum d'entrée



Referência Reference Référence	Tipo Type Type	D. máx. entrada Max. Fit size D. max. d'entrée	Fixação Fixation Fixation	Miolo Silencer Intérieur	Material Material Matériel
562B2-48	Redonda Round Rond	48mm	Parafuso Screw Vis	Com miolo With silencer Avec intérieur	Inox
562B2-58	Redonda Round Rond	58mm	Parafuso Screw Vis	Com miolo With silencer Avec intérieur	Inox

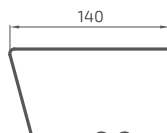
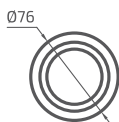

PONTEIRA DUPLA
DOUBLE TRIM
D'ÉCHAPPEMENT DOUBLE

563



Saída de escape
Exhaust exit
Sortie d'échappement



Sem miolo
Without silencer
Sans intérieur



Solda
Welding
Soudure



Diâmetro máximo entrada
Maximum fit size
Diamètre maximum d'entrée



Referência Reference Référence	Tipo Type Type	D. máx. entrada Max. fit size D. max. d'entrée	Fixação Fixation Fixation	Miolo Silencer Intérieur	Material Material Matériel
563.1-60	Dupla Double Double	60mm	Solda Welding Soudure	Sem miolo Without silencer Sans intérieur	Inox

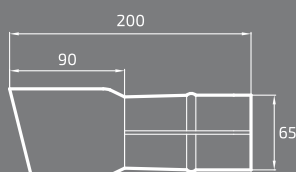
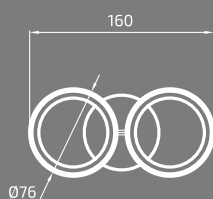

PONTEIRA REDONDA
ROUND TRIM
EMBOUT ROND

574



Saída de escape
Exhaust exit
Sortie d'échappement



Miolo perfurado
Perforated silencer
Intérieur perforé



Com miolo
With silencer
Avec intérieur



Solda
Welding
Soudure



Diâmetro máximo entrada
Maximum Fit size
Diamètre maximum d'entrée



Referência Reference Référence	Tipo Type Type	D. máx. entrada Max. Fit size D. max. d'entrée	Fixação Fixation Fixation	Miolo Silencer Intérieur	Material Material Matériel
574A1-47	Redonda Round Rond	47mm	Solda Welding Soudure	Perfurado Perforated Perforé	Inox
574B1-47	Redonda Round Rond	47mm	Solda Welding Soudure	Com miolo With silencer Avec intérieur	Inox

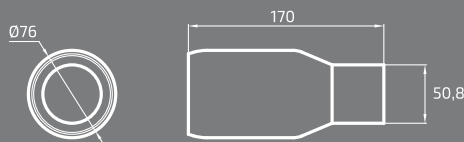

PONTEIRA REDONDA
ROUND TRIM
EMBOUT ROND

575



Saída de escape
Exhaust exit
Sortie d'échappement



Miolo perfurado
Perforated silencer
Intérieur perforé



Com miolo
With silencer
Avec intérieur



Solda
Welding
Soudure



Diâmetro máximo entrada
Maximum Fit size
Diamètre maximum d'entrée



Referência Reference Référence	Tipo Type Type	D. máx. entrada Max. Fit size D. max. d'entrée	Fixação Fixation Fixation	Miolo Silencer Intérieur	Material Material Matériel
575A1-47	Redonda Round Rond	47mm	Solda Welding Soudure	Perfurado Perforated Perforé	Inox
575B1-47	Redonda Round Rond	47mm	Solda Welding Soudure	Com miolo With silencer Avec intérieur	Inox

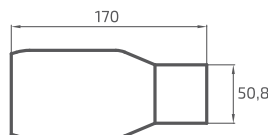
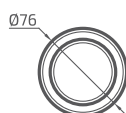

PONTEIRA REDONDA
ROUND TRIM
EMBOU ROND

576



Saída de escape
Exhaust exit
Sortie d'échappement



Miolo perfurado
Perforated silencer
Intérieur perforé



Solda
Welding
Soudure



Diâmetro máximo entrada
Maximum Fit size
Diamètre maximum d'entrée

Referência Reference Référence	Tipo Type Type	D. máx. entrada Max. Fit size D. max. d'entrée	Fixação Fixation Fixation	Miolo Silencer Intérieur	Material Material Matériel
576A1-60	Redonda Round Rond	60mm	Solda Welding Soudure	Perfurado Perforated Perforé	Inox

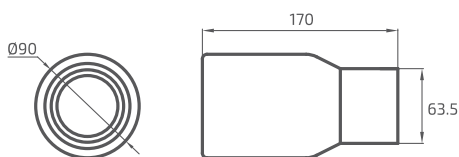

PONTEIRA REDONDA
 ROUND TRIM
 EMBOUT ROND

577



Saída de escape
 Exhaust exit
 Sortie d'échappement



Miolo perfurado
 Perforated silencer
 Intérieur perforé



Solda
 Welding
 Soudure



Diâmetro máximo entrada
 Maximum Fit size
 Diamètre maximum d'entrée



Referência Reference Référence	Tipo Type Type	D. máx. entrada Max. Fit size D. max. d'entrée	Fixação Fixation Fixation	Miolo Silencer Intérieur	Material Material Matériel
577A1-60	Redonda Round Rond	60mm	Solda Welding Soudure	Perfurado Perforated Perforé	Inox

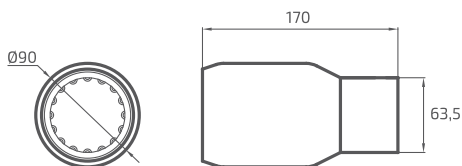

PONTEIRA REDONDA
ROUND TRIM
EMBOUT ROND

578



Saída de escape
Exhaust exit
Sortie d'échappement



Com miolo
With silencer
Avec intérieur



Solda
Welding
Soudure



Diâmetro máximo entrada
Maximum Fit size
Diamètre maximum d'entrée



Referência Reference Référence	Tipo Type Type	D. máx. entrada Max. Fit size D. max. d'entrée	Fixação Fixation Fixation	Miolo Silencer Intérieur	Material Material Matériel
578B1-60	Redonda Round Rond	60mm	Solda Welding Soudure	Com miolo With silencer Avec intérieur	Inox

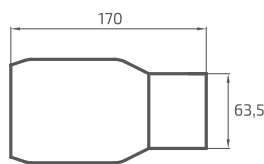
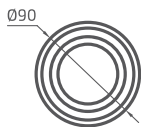

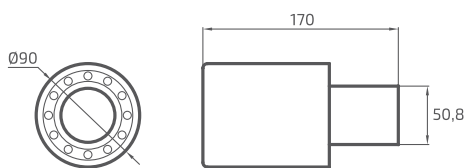

Referência Reference Référence	Tipo Type Type	D. máx. entrada Max. Fit size D. max. d'entrée	Fixação Fixation Fixation	Miolo Silencer Intérieur	Material Material Matériel
579B1-47	Redonda Round Rond	47mm	Solda Welding Soudure	Com miolo With silencer Avec intérieur	Inox



Saída de escape
Exhaust exit
Sortie d'échappement



Com miolo
With silencer
Avec intérieur



Solda
Welding
Soudure



Diâmetro máximo entrada
Maximum Fit size
Diamètre maximum d'entrée



579

PONTEIRA REDONDA
ROUND TRIM
EMBOUT ROND

PONTEIRA REDONDA
ROUND TRIM
EMBOUT ROND

580



Saída de escape
Exhaust exit
Sortie d'échappement



Com miolo
With silencer
Avec intérieur



Solda
Welding
Soudure



Diâmetro máximo entrada
Maximum Fit size
Diamètre maximum d'entrée

Referência Reference Référence	Tipo Type Type	D. máx. entrada Max. Fit size D. max. d'entrée	Fixação Fixation Fixation	Miolo Silencer Intérieur	Material Material Matériel
580B1-47	Redonda Round Rond	47mm	Solda Welding Soudure	Com miolo With silencer Avec intérieur	Inox

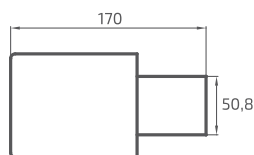
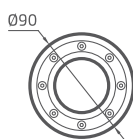

PONTEIRA REDONDA
 ROUND TRIM
 EMBOUT ROND

584



Saída de escape
 Exhaust exit
 Sortie d'échappement



Com miolo
 With silencer
 Avec intérieur



Solda
 Welding
 Soudure



Diâmetro máximo entrada
 Maximum Fit size
 Diamètre maximum d'entrée



Referência Reference Référence	Tipo Type Type	D. máx. entrada Max. Fit size D. max. d'entrée	Fixação Fixation Fixation	Miolo Silencer Intérieur	Material Material Matériel
584B1-85	Redonda Round Rond	85mm	Solda Welding Soudure	Com miolo With silencer Avec intérieur	Inox

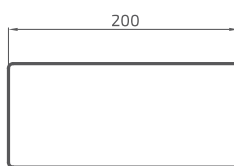
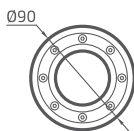

PONTEIRA DUPLA
DOUBLE TRIM
D'ÉCHAPPEMENT DOUBLE

PAR
SET
PAIRE

586



ESQUERDA
LEFT
GAUCHE



Saída de escape
Exhaust exit
Sortie d'échappement



Sem miolo
Without silencer
Sans intérieur



Solda
Welding
Soudure



Diâmetro máximo entrada
Maximum Fit size
Diamètre maximum d'entrée



DIREITA
RIGHT
DROIT

Referência Reference Référence	Tipo Type Type	D. máx. entrada Max. Fit size D. max. d'entrée	Fixação Fixation Fixation	Miolo Silencer Intérieur	Material Material Matériel
586.1-60 set	Dupla Double Double	60mm	Solda Welding Soudure	Sem miolo Without silencer Sans intérieur	Inox

Par
Set
Paire

Esquerda
Left
Gauche

Direita
Right
Droit

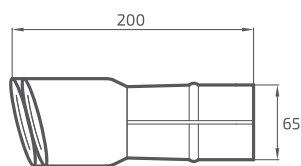
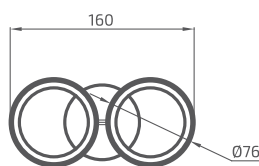

PONTEIRA DUPLA
DOUBLE TRIM
D'ÉCHAPPEMENT DOUBLE

587

PAR
SET
PAIRE



Saída de escape
Exhaust exit
Sortie d'échappement



Sem miolo
Without silencer
Sans intérieur



Solda
Welding
Soudure



Diâmetro máximo entrada
Maximum Fit size
Diamètre maximum d'entrée



DIREITA
RIGHT
DROIT



ESQUERDA
LEFT
GAUCHE

Referência Reference Référence	Tipo Type Type	D. máx. entrada Max. Fit size D. max. d'entrée	Fixação Fixation Fixation	Miolo Silencer Intérieur	Material Material Matériel
587.1-60 set	Dupla Double Double	60mm	Solda Welding Soudure	Sem miolo Without silencer Sans intérieur	Inox

Par
Set
Paire

Esquerda
Left
Gauche

Direita
Right
Droit

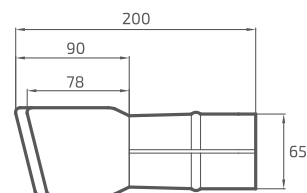
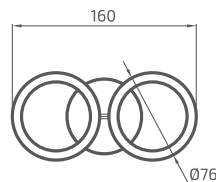

PONTEIRA RETANGULAR
RECTANGULAR TRIM
EMBOUT RECTANGULAIRE

588



Saída de escape
Exhaust exit
Sortie d'échappement



Com miolo
With silencer
Avec intérieur



Solda
Welding
Soudure



Díâmetro máximo entrada
Maximum fit size
Diamètre maximum d'entrée

Referência Reference Référence	Tipo Type Type	D. máx. entrada Max. fit size D. max. d'entrée	Fixação Fixation Fixation	Miolo Silencer Intérieur	Material Material Matériel
588B1-60	Retangular Rectangular Rectangulaire	60mm	Solda Welding Soudure	Com miolo With silencer Avec intérieur	Inox

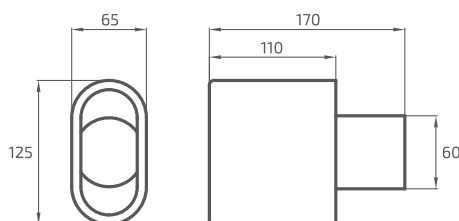

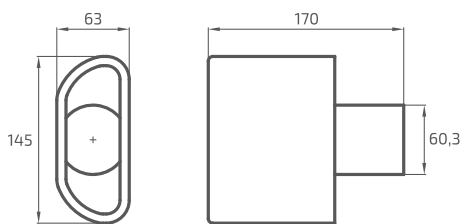

Referência Reference Référence	Tipo Type Type	D. máx. entrada Max. Fit size D. max. d'entrée	Fixação Fixation Fixation	Miolo Silencer Intérieur	Material Material Matériel
589.1-57	Retangular Rectangular Rectangulaire	57mm	Solda Welding Soudure	Sem miolo Without silencer Sans intérieur	Inox



Saída de escape
Exhaust outlet
Sortie d'échappement



Sem miolo
Cored
Évidées



Solda
Solder
Soudure



Diâmetro máximo entrada
Maximum Fit size
Diamètre maximum d'entrée



589

PONTEIRA RETANGULAR
RECTANGULAR TRIM
EMBOU RECTANGULAIRE

PONTEIRA DIESEL
DIESEL TRIM
EMBOUOT D'ÉCHAPPEMENT DIESEL

591

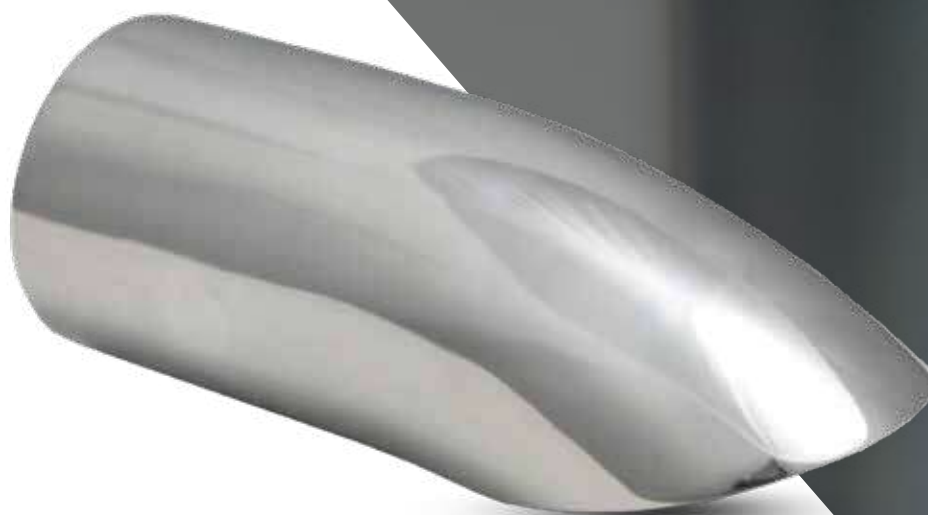

Saída de escape
Exhaust exit
Sortie d'échappement



Sem miolo
Without silencer
Sans intérieur



Solda
Welding
Soudure



Diâmetro máximo entrada
Maximum Fit size
Diamètre maximum d'entrée

Referência Reference Référence	Tipo Type Type	D. máx. entrada Max. Fit size D. max. d'entrée	Fixação Fixation Fixation	Miolo Silencer Intérieur	Material Material Matériel
591.1x200	Diesel	60mm	Solda Welding Soudure	Sem miolo Without silencer Sans intérieur	Inox

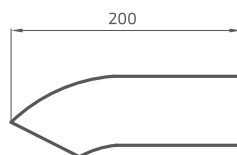

PONTEIRA DTM
DTM TRIM
EMBOUIT DTM

592



Saída de escape
Exhaust exit
Sortie d'échappement



S/ miolo
Without silencer
Sans intérieur



Solda
Welding
Soudure



Diâmetro máximo entrada
Maximum fit size
Diamètre maximum d'entrée

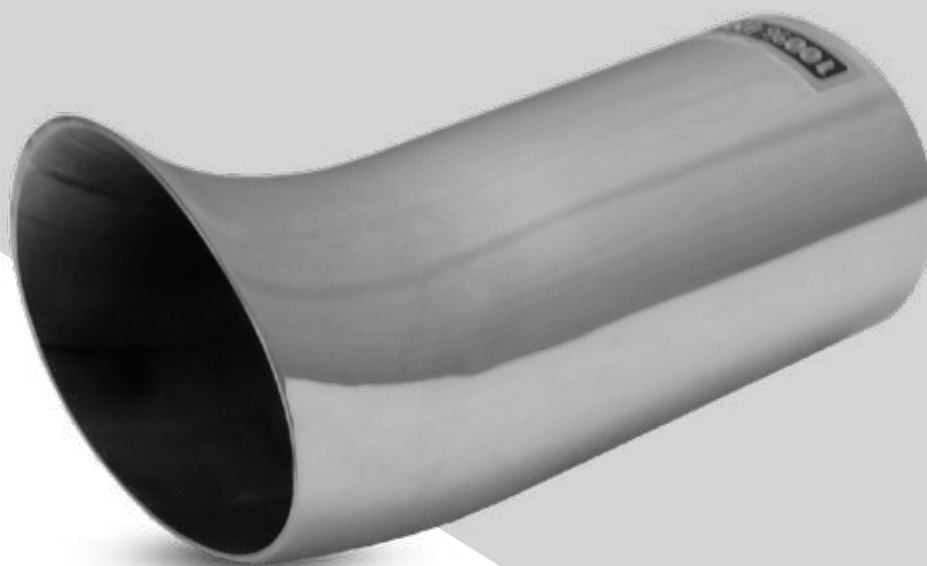

Referência Reference Référence	Tipo Type Type	D. máx. entrada Max. Fit size D. max. d'entrée	Fixação Fixation Fixation	Miolo Silencer Intérieur	Material Material Matériel
592.1x170	DTM	60mm	Solda Welding Soudure	Sem miolo Without silencer Sans intérieur	Inox
592.1x200	DTM	60mm	Solda Welding Soudure	Sem miolo Without silencer Sans intérieur	Inox

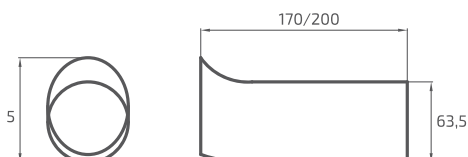

PONTEIRA DIESEL
DIESEL TRIM
EMBOU D'ÉCHAPPEMENT DIESEL

593



Saída de escape
Exhaust exit
Sortie d'échappement



Sem miolo
Without silencer
Sans intérieur



Solda
Welding
Soudure



Diâmetro máximo entrada
Maximum fit size
Diamètre maximum d'entrée

Referência Reference Référence	Tipo Type Type	D. máx. entrada Max. fit size D. max. d'entrée	Fixação Fixation Fixation	Miolo Silencer Intérieur	Material Material Matériel
593.1x200	Diesel	73mm	Solda Welding Soudure	Sem miolo Without silencer Sans intérieur	Inox

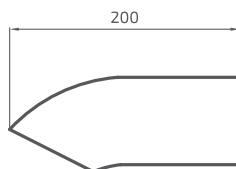
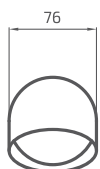

PONTEIRA DUPLA
DOUBLE TRIM
D'ÉCHAPPEMENT DOUBLE

596



Saída de escape
Exhaust exit
Sortie d'échappement



Sem miolo
Without silencer
Sans intérieur



Solda
Welding
Soudure



Diâmetro máximo entrada
Maximum fit size
Diamètre maximum d'entrée



Referência Reference Référence	Tipo Type Type	D. máx. entrada Max. fit size D. max. d'entrée	Fixação Fixation Fixation	Miolo Silencer Intérieur	Material Material Matériel
--------------------------------------	----------------------	------------------------------------------------------	---------------------------------	--------------------------------	----------------------------------

596.1-60	Dupla Double Double	60mm	Solda Welding Soudure	Sem miolo Without silencer Sans intérieur	Inox
----------	---------------------------	------	-----------------------------	-------------------------------------------------	------

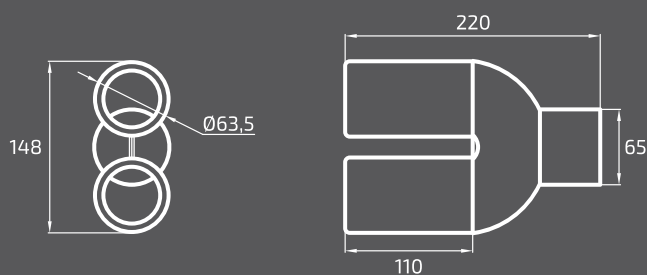

PONTEIRA DUPLA
DOUBLE TRIM
D'ÉCHAPPEMENT DOUBLE

597



Saída de escape
Exhaust exit
Sortie d'échappement



Sem miolo
Without silencer
Sans intérieur



Solda
Welding
Soudure



Diâmetro máximo entrada
Maximum fit size
Diamètre maximum d'entrée

Referência Reference Référence	Tipo Type Type	D. máx. entrada Max. fit size D. max. d'entrée	Fixação Fixation Fixation	Miolo Silencer Intérieur	Material Material Matériel
597.1-60	Dupla Double Double	60mm	Solda Welding Soudure	Sem miolo Without silencer Sans intérieur	Inox

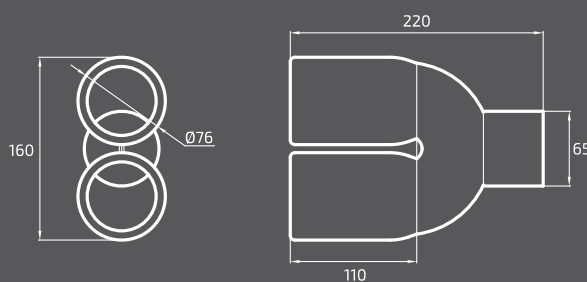

PONTEIRA DUPLA
DOUBLE TRIM
D'ÉCHAPPEMENT DOUBLE

598



Saída de escape
Exhaust exit
Sortie d'échappement



Sem miolo
Without silencer
Sans intérieur

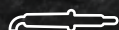

Solda
Welding
Soudure



Diâmetro máximo entrada
Maximum fit size
Diamètre maximum d'entrée



Referência Reference Référence	Tipo Type Type	D. máx. entrada Max. fit size D. max. d'entrée	Fixação Fixation Fixation	Miolo Silencer Intérieur	Material Material Matériel
598.1-60	Dupla Double Double	60mm	Solda Welding Soudure	Sem miolo Without silencer Sans intérieur	Inox

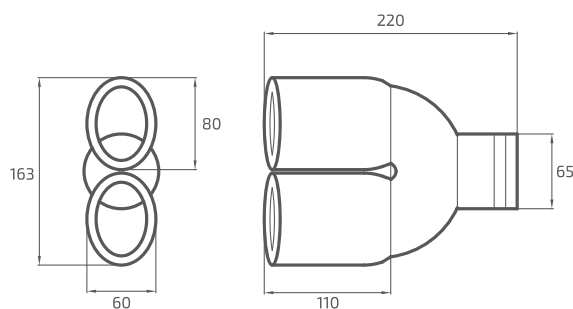

PONTEIRA DUPLA
DOUBLE TRIM
D'ÉCHAPPEMENT DOUBLE

599



Saída de escape
Exhaust exit
Sortie d'échappement



Sem miolo
Without silencer
Sans intérieur

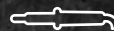

Solda
Welding
Soudure



Diâmetro máximo entrada
Maximum Fit size
Diamètre maximum d'entrée



Referência Reference Référence	Tipo Type Type	D. máx. entrada Max. Fit size D. max. d'entrée	Fixação Fixation Fixation	Miolo Silencer Intérieur	Material Material Matériel
599.1-60	Dupla Double Double	60mm	Solda Welding Soudure	Sem miolo Without silencer Sans intérieur	Inox

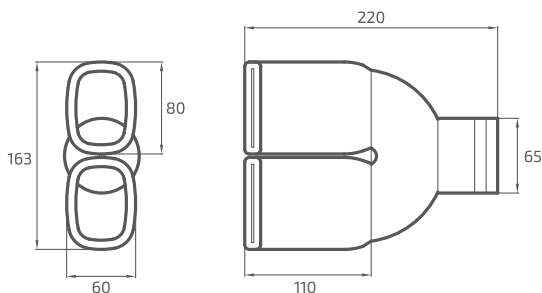

PONTEIRA DUPLA
DOUBLE TRIM
D'ÉCHAPPEMENT DOUBLE

600



Saída de escape
Exhaust exit
Sortie d'échappement



Sem miolo
Without silencer
Sans intérieur



Solda
Welding
Soudure



Diâmetro máximo entrada
Maximum fit size
Diamètre maximum d'entrée



Referência <i>Reference</i> <i>Référence</i>	Tipo <i>Type</i> <i>Type</i>	D. máx. entrada <i>Max. fit size</i> <i>D. max. d'entrée</i>	Fixação <i>Fixation</i> <i>Fixation</i>	Miolo <i>Silencer</i> <i>Intérieur</i>	Material <i>Material</i> <i>Matériel</i>
600.1-60	Dupla <i>Double</i> <i>Double</i>	60mm	Solda <i>Welding</i> <i>Soudure</i>	Sem miolo <i>Without silencer</i> <i>Sans intérieur</i>	Inox

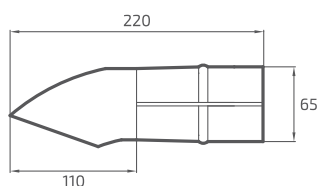
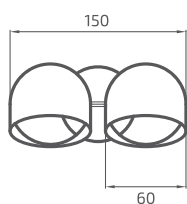

PONTEIRA DUPLA
DOUBLE TRIM
D'ÉCHAPPEMENT DOUBLE

601



Saída de escape
Exhaust exit
Sortie d'échappement



Sem miolo
Without silencer
Sans intérieur



Solda
Welding
Soudure



Diâmetro máximo entrada
Maximum fit size
Diamètre maximum d'entrée



Referência Reference Référence	Tipo Type Type	D. máx. entrada Max. fit size D. max. d'entrée	Fixação Fixation Fixation	Miolo Silencer Intérieur	Material Material Matériel
601.1-60	Dupla Double Double	60mm	Solda Welding Soudure	Sem miolo Without silencer Sans intérieur	Inox

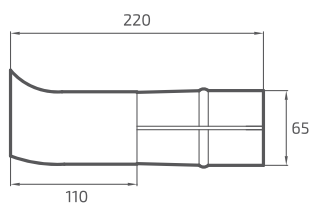
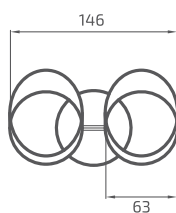

PONTEIRA DUPLA
DOUBLE TRIM
D'ÉCHAPPEMENT DOUBLE

657



Saída de escape
Exhaust exit
Sortie d'échappement



Sem miolo
Without silencer
Sans intérieur



Com miolo
With silencer
Avec intérieur



Solda
Welding
Soudure



Diâmetro máximo entrada
Maximum fit size
Diamètre maximum d'entrée



Referência Reference Référence	Tipo Type Type	D. máx. entrada Max. fit size D. max. d'entrée	Fixação Fixation Fixation	Miolo Silencer Intérieur	Material Material Matériel
657.1-60	Dupla Double Double	60mm	Solda Welding Soudure	Sem miolo Without silencer Sans intérieur	Inox
657B1-60	Dupla Double Double	60mm	Solda Welding Soudure	Com miolo With silencer Avec intérieur	Inox

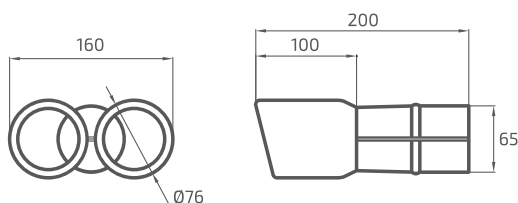

PONTEIRA DUPLA
DOUBLE TRIM
D'ÉCHAPPEMENT DOUBLE

PAR
SET
PAIRE

657



ESQUERDA
LEFT
GAUCHE



DIREITA
RIGHT
DROIT



Saída de escape
Exhaust exit
Sortie d'échappement



Com miolo
With silencer
Avec intérieur



Solda
Welding
Soudure



Diâmetro máximo entrada
Maximum fit size
Diamètre maximum d'entrée

Referência Reference Référence	Tipo Type Type	D. máx. entrada Max. Fit size D. max. d'entrée	Fixação Fixation Fixation	Miolo Silencer Intérieur	Material Material Matériel
657B1-60 set	Dupla Double Double	60mm	Solda Welding Soudure	Com miolo With silencer Avec intérieur	Inox

Par
Set
Paire

Esquerda
Left
Gauche

Direita
Right
Droit

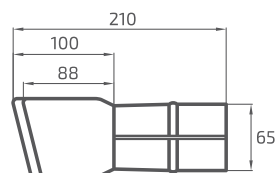
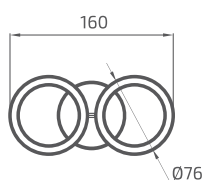

PONTEIRA OVAL
OVAL TRIM
EMBOUT OVALE

658

PAR
SET
PAIRE



Saída de escape
Exhaust exit
Sortie d'échappement



Sem miolo
Without silencer
Sans intérieur



Solda
Welding
Soudure



Diâmetro máximo entrada
Maximum fit size
Diamètre maximum d'entrée

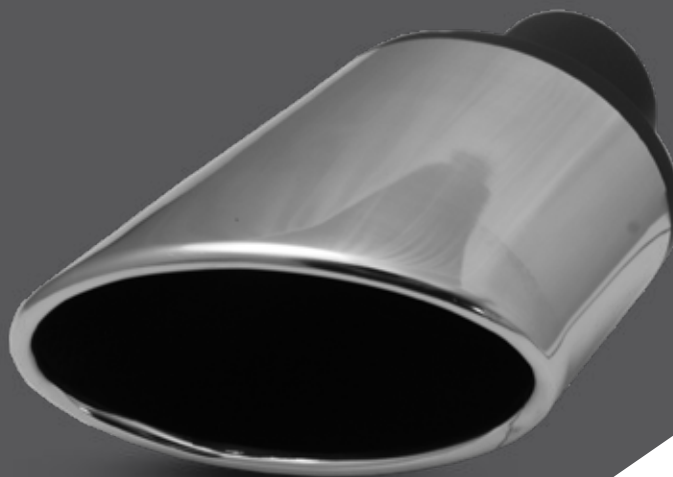

DIREITA
RIGHT
DROIT



ESQUERDA
LEFT
GAUCHE

Referência Reference Référence	Tipo Type Type	D. máx. entrada Max. fit size D. max. d'entrée	Fixação Fixation Fixation	Miolo Silencer Intérieur	Material Material Matériel
658.1-57 set	Oval Oval Ovale	57mm	Solda Welding Soudure	Sem miolo Without silencer Sans intérieur	Inox

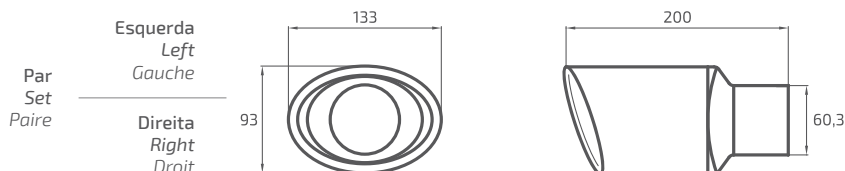

PONTEIRA RETANGULAR
RECTANGULAR TRIM
EMBOUT RECTANGULAIRE

661



Saída de escape
Exhaust exit
Sortie d'échappement



Sem miolo
Without silencer
Sans intérieur



Solda
Welding
Soudure



Diâmetro máximo entrada
Maximum fit size
Diamètre maximum d'entrée

Referência Reference Référence	Tipo Type Type	D. máx. entrada Max. fit size D. max. d'entrée	Fixação Fixation Fixation	Miolo Silencer Intérieur	Material Material Matériel
661.1	Retangular Rectangular Rectangulaire	55mm	Solda Welding Soudure	Sem miolo Without silencer Sans intérieur	Inox

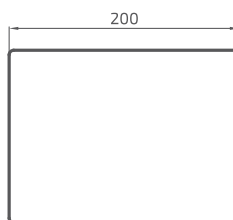
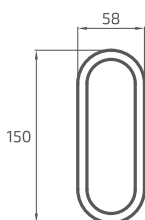

PONTEIRA RETANGULAR
RECTANGULAR TRIM
EMBOUT RECTANGULAIRE

662



Saída de escape
Exhaust exit
Sortie d'échappement



Sem miolo
Without silencer
Sans intérieur

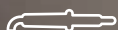

Solda
Welding
Soudure



Diâmetro máximo entrada
Maximum fit size
Diamètre maximum d'entrée



Referência Reference Référence	Tipo Type Type	D. máx. entrada Max. fit size D. max. d'entrée	Fixação Fixation Fixation	Miolo Silencer Intérieur	Material Material Matériel
662.1-57	Retangular Rectangular Rectangulaire	57mm	Solda Welding Soudure	Sem miolo Without silencer Sans intérieur	Inox

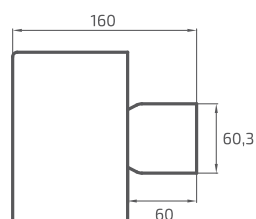
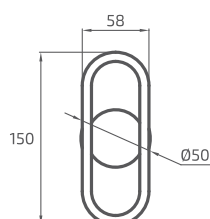

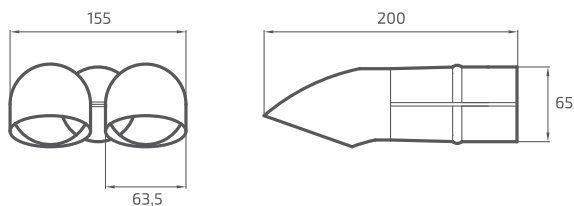

Referência Reference Référence	Tipo Type Type	D. máx. entrada Max. Fit size D. max. d'entrée	Fixação Fixation Fixation	Miolo Silencer Intérieur	Material Material Matériel
663.1-60	Dupla Double Double	60mm	Solda Welding Soudure	Sem miolo Without silencer Sans intérieur	Inox



Saída de escape
Exhaust exit
Sortie d'échappement



Sem miolo
Without silencer
Sans intérieur



Solda
Welding
Soudure



Díâmetro máximo entrada
Maximum Fit size
Diamètre maximum d'entrée

663

PONTEIRA DUPLA
DOUBLE TRIM
D'ÉCHAPPEMENT DOUBLE

PONTEIRA DUPLA
DOUBLE TRIM
D'ÉCHAPPEMENT DOUBLE

664



Saída de escape
Exhaust exit
Sortie d'échappement



Sem miolo
Without silencer
Sans intérieur



Solda
Welding
Soudure



Diâmetro máximo entrada
Maximum fit size
Diamètre maximum d'entrée



Referência Reference Référence	Tipo Type Type	D. máx. entrada Max. fit size D. max. d'entrée	Fixação Fixation Fixation	Miolo Silencer Intérieur	Material Material Matériel
664.1-60	Dupla Double Double	60mm	Solda Welding Soudure	Sem miolo Without silencer Sans intérieur	Inox

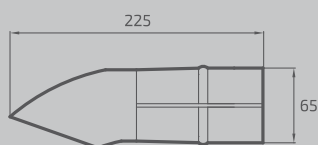
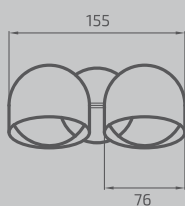

PONTEIRA DIESEL
DIESEL TRIM
EMBOUT D'ÉCHAPPEMENT DIESEL

665



Saída de escape
Exhaust exit
Sortie d'échappement



Sem miolo
Without silencer
Sans intérieur



Solda
Welding
Soudure



Diâmetro máximo entrada
Maximum fit size
Diamètre maximum d'entrée



Referência Reference Référence	Tipo Type Type	D. máx. entrada Max. fit size D. max. d'entrée	Fixação Fixation Fixation	Miolo Silencer Intérieur	Material Material Matériel
665.1-57	Diesel	57mm	Solda Welding Soudure	Sem miolo Without silencer Sans intérieur	Inox

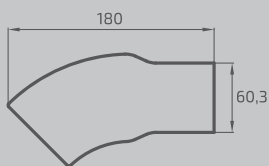

PONTEIRA DUPLA
DOUBLE TRIM
D'ÉCHAPPEMENT DOUBLE

681

PAR
SET
PAIRE



Saída de escape
Exhaust exit
Sortie d'échappement



Com miolo
With silencer
Avec intérieur



Solda
Welding
Soudure



Diâmetro máximo entrada
Maximum fit size
Diamètre maximum d'entrée



ESQUERDA
LEFT
GAUCHE



DIREITA
RIGHT
DROIT

Referência Reference Référence	Tipo Type Type	D. máx. entrada Max. fit size D. max. d'entrée	Fixação Fixation Fixation	Miolo Silencer Intérieur	Material Material Matériel
681B1-60 set	Dupla Double Double	60mm	Solda Welding Soudure	Com miolo With silencer Avec intérieur	Inox

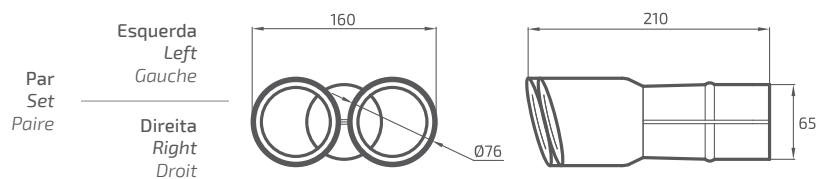

PONTEIRA OVAL
OVAL TRIM
EMBOUT OVALE

682



Saída de escape
Exhaust exit
Sortie d'échappement



Com miolo
With silencer
Avec intérieur



Solda
Welding
Soudure



Diâmetro máximo entrada
Maximum fit size
Diamètre maximum d'entrée



Referência Reference Référence	Tipo Type Type	D. máx. entrada Max. Fit size D. max. d'entrée	Fixação Fixation Fixation	Miolo Silencer Intérieur	Material Material Matériel
682B1-57 set	Oval Oval Ovale	57mm	Solda Welding Soudure	Com miolo With silencer Avec intérieur	Inox

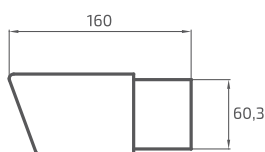
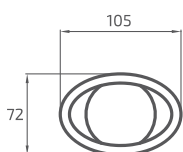

PONTEIRA REDONDA
 ROUND TRIM
 EMBOUT ROND

684



Saída de escape
 Exhaust exit
 Sortie d'échappement



Com miolo
 With silencer
 Avec intérieur



Solda
 Welding
 Soudure



Diâmetro máximo entrada
 Maximum fit size
 Diamètre maximum d'entrée



Referência Reference Référence	Tipo Type Type	D. máx. entrada Max. fit size D. max. d'entrée	Fixação Fixation Fixation	Miolo Silencer Intérieur	Material Material Matériel
684B1-40	Redonda Round Rond	40mm	Solda Welding Soudure	Com miolo With silencer Avec intérieur	Inox

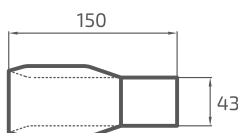

PONTEIRA REDONDA
ROUND TRIM
EMBOUT ROND

685



Saída de escape
Exhaust exit
Sortie d'échappement



Com miolo
With silencer
Avec intérieur



Solda
Welding
Soudure



Diâmetro máximo entrada
Maximum Fit size
Diamètre maximum d'entrée



Referência Reference Référence	Tipo Type Type	D. máx. entrada Max. Fit size D. max. d'entrée	Fixação Fixation Fixation	Miolo Silencer Intérieur	Material Material Matériel
685B1-57x130	Redonda Round Rond	57mm	Solda Welding Soudure	Com miolo With silencer Avec intérieur	Inox
685B1-57x160	Redonda Round Rond	57mm	Solda Welding Soudure	Com miolo With silencer Avec intérieur	Inox

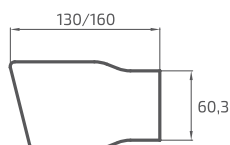
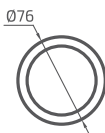

PONTEIRA DUPLA
DOUBLE TRIM
D'ÉCHAPPEMENT DOUBLE

686



Saída de escape
Exhaust exit
Sortie d'échappement



Com miolo
With silencer
Avec intérieur



Solda
Welding
Soudure



Diâmetro máximo entrada
Maximum fit size
Diamètre maximum d'entrée



Referência Reference Référence	Tipo Type Type	D. máx. entrada Max. fit size D. max. d'entrée	Fixação Fixation Fixation	Miolo Silencer Intérieur	Material Material Matériel
686B1-60	Dupla Double Double	60mm	Solda Welding Soudure	Com miolo With silencer Avec intérieur	Inox

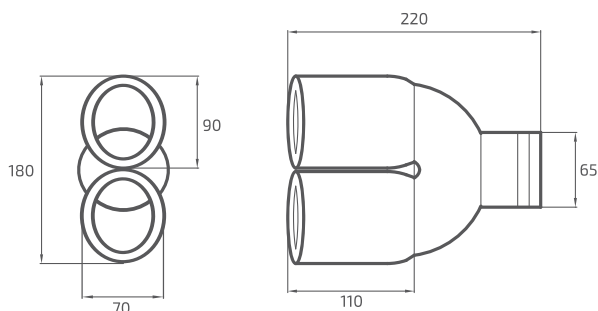



UNIÃO EUROPEIA
Fundo Europeu
de Desenvolvimento Regional



www.ivol.pt